

## SWIMMING POOL VESSEL SOLUTIONS

INTEGRAL AESTHETICS FOR POOLS AND TERRACES  
ESTÉTICA INTEGRAL PARA PISCINA Y TERRAZA



**Pool Solutions**  
Soluciones para piscina



**A** COVE POOL SOLUTIONS  
SOLUCIONES DE ESQUINAS EN PISCINAS



**B** STEP 120x33 CORNER SOLUTIONS  
SOLUCIONES DE ESQUINA PELDAÑO 120x33

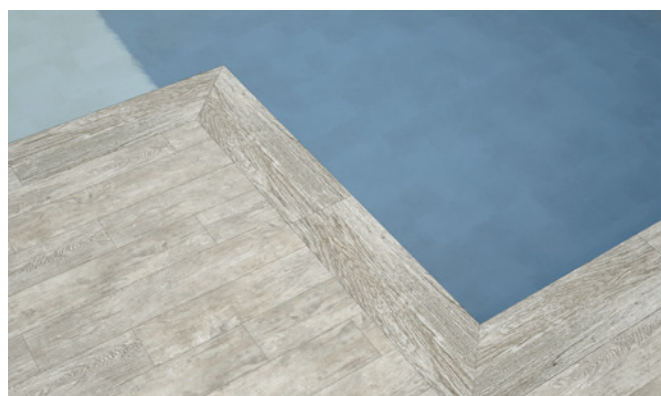

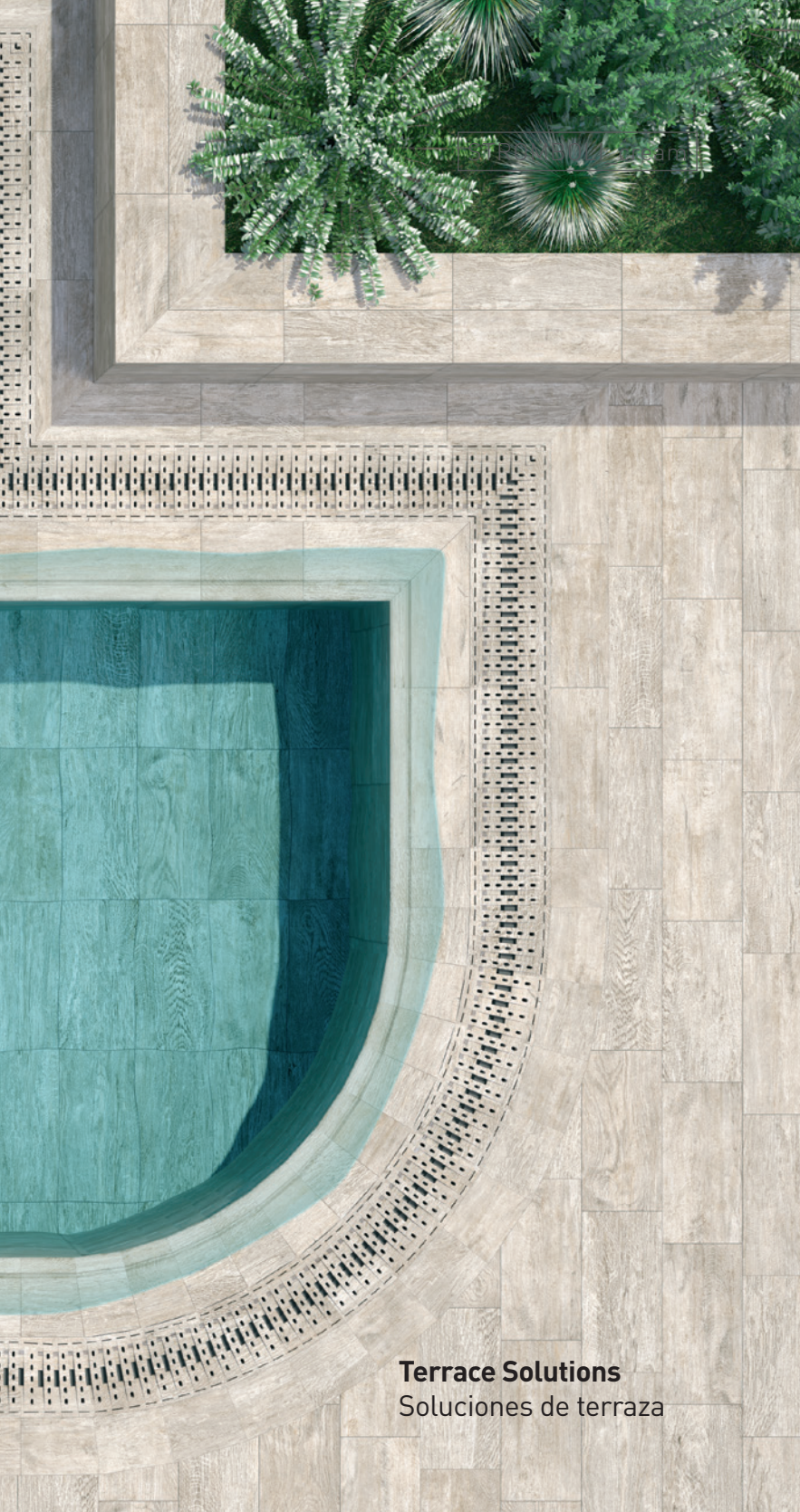

**Terrace Solutions**  
Soluciones de terraza



**One piece for  
each solutions**

Una pieza para  
cada solución

pools  
+  
terraces

**Pools systems in combination  
with our terrace series**

Sistemas de piscina  
en combinación con nuestras  
series de terraza

© VIERTEAGUAS CORNER SOLUTIONS  
SOLUCIONES DE ESQUINA VIERTEAGUAS



# SILL AND STEP

**BASIC PIECES.** With our products we take a step further in integrating your pool with the environment, offering the possibility of combining any of our pool systems with the finish of your terrace.

# VIERTEAGUAS Y PELDAÑO

**PIEZAS BÁSICAS.** Con nuestros productos damos un paso más en la integración de su piscina con el medio ambiente, ofreciendo la posibilidad de combinar cualquiera de nuestros sistemas de piscinas con el acabado de su terraza.

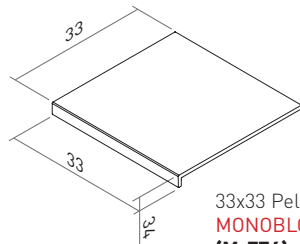
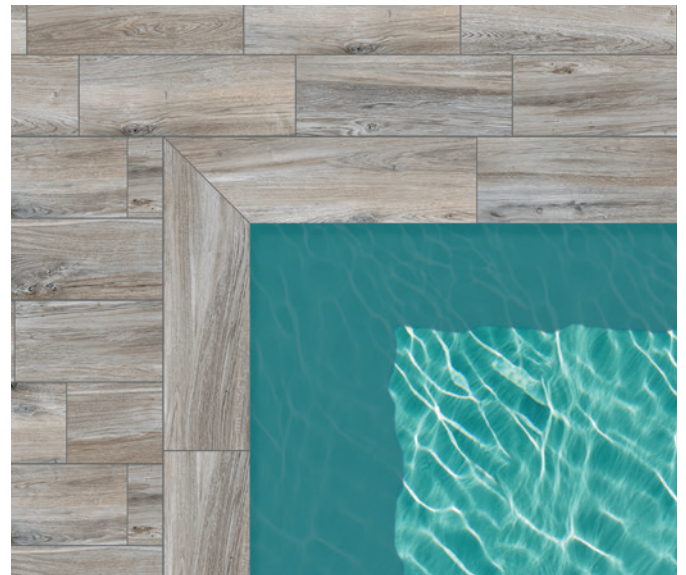

33x33 Peldaño recto  
**MONOBLOCK** 3-C  
(M-776) pz

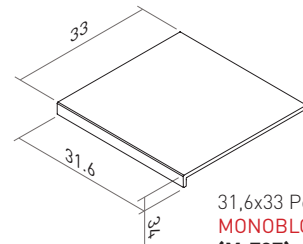

31,6x33 Peldaño recto  
**MONOBLOCK** 3-C  
(M-707) pz

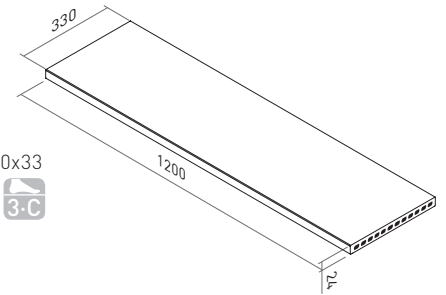

120x33 Complete step  
Peldaño completo 120x33  
**MONOBLOCK** 3-C  
120x33 (M-419) pz

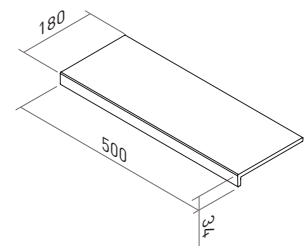

Sill / Vierendeaguas  
**MONOBLOCK** 3-C  
18x50 cm (M-392) pz

## Width extra edge solution

Solución para un borde más ancho

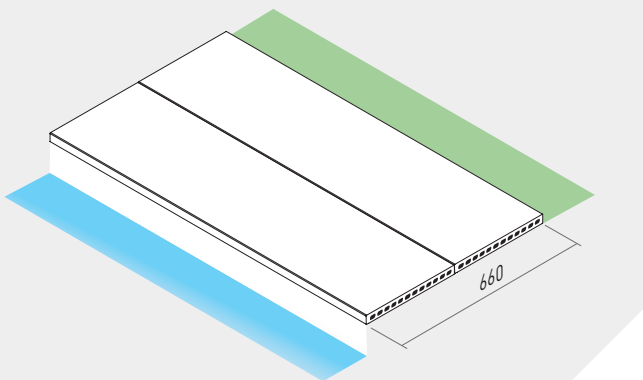

## Combine it with our drainage grids

Combinalo con nuestras rejillas de drenaje

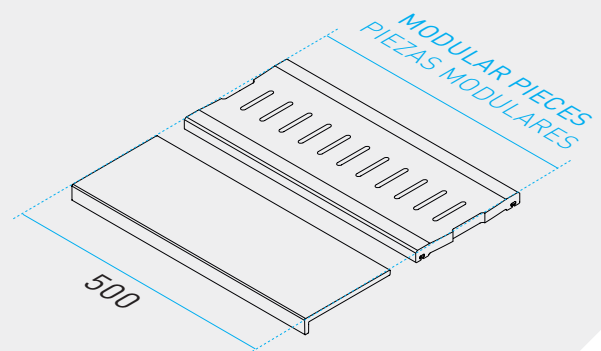

## INSIDE POOL SOLUTION

SOLUCIÓN PARA EL INTERIOR DE LA PISCINA



## BENCHES AND LOUNGER BEDS

BANCOS Y TUMBONAS



## INFINITY POOL SOLUTION

SOLUCIÓN PISCINA INFINITY

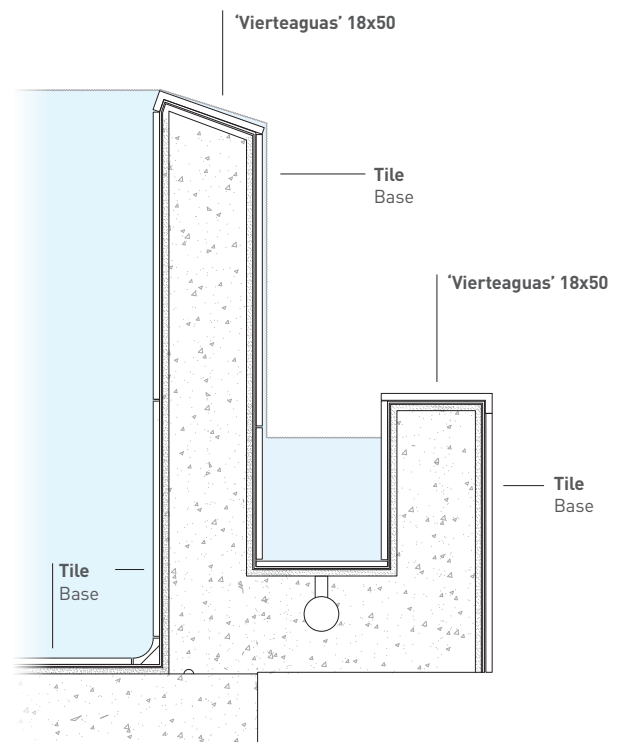

# COVE POOL SYSTEM

INSIDE POOL SOLUTIONSM

## SISTEMA MEDIA CAÑA

SOLUCIONES PARA EL VASO DE LA PISCINA



① COVE POOL OUTER  
MEDIA CAÑA EXTERIOR  
MDCA E000  
[M-773] PZ

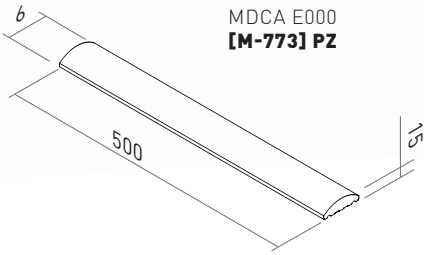

② COVE POOL INNER  
MEDIA CAÑA INTERIOR  
MDCA I000  
[M-773] PZ

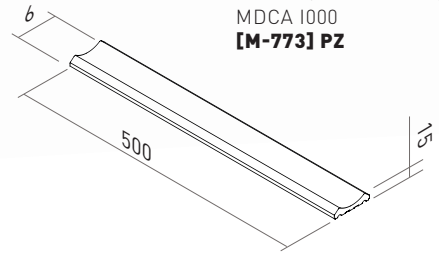

③ COVE POOL INNER CORNER  
MEDIA CAÑA ESQUINA INTERIOR  
MDCA E100  
[M-774] PZ



④ COVE POOL OUTER CORNER  
MEDIA CAÑA ESQUINA EXTERIOR  
MDCA EE00  
[M-774] PZ



⑤ COVE POOL INNER ANGLE  
MEDIA CAÑA ÁNGULO INTERIOR  
MDCA AI00  
[M-774] PZ

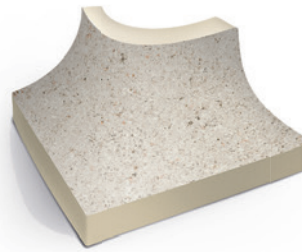

⑥ COVE POOL OUTER ANGLE  
MEDIA CAÑA ÁNGULO EXTERIOR  
MDCA AE00  
[M-774] PZ

### Available colours for pools and terraces

Colores disponibles para piscina y terraza



Woods Arctic



Woods Nordic



Woods Olivo

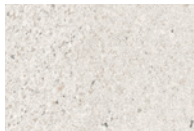

Stromboli Light

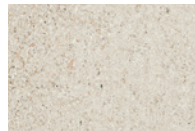

Stromboli Cream



Stromboli Silver

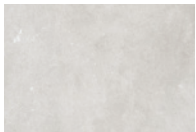

Cements Snow

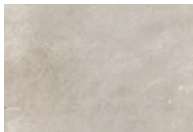

Cements Smoke

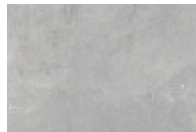

Cements Warm



Rainforest Blanco



Rainforest Musgo



Sea Rock Marfil



Sea Rock Caramel

### TECHNICAL INFORMATION

INFORMACIÓN TÉCNICA

**MONOBLOCK** ONE PIECE WITHOUT GLUED  
UNA PIEZA, SIN PEGADO



UNE ENV 12633  
Clase 3



DIN 51130  
R12



DIN 51097  
Clase C



EN ISO 10545-12  
✓



EN ISO 10545-13  
GA / GLA / GHA



NOISELESS  
SILENCIOSO



LONG LIFE  
LARGA VIDA



EASY  
FÁCIL

**COVE POOL SYSTEM DETAIL**  
DETALLE SISTEMA MEDIA CAÑA

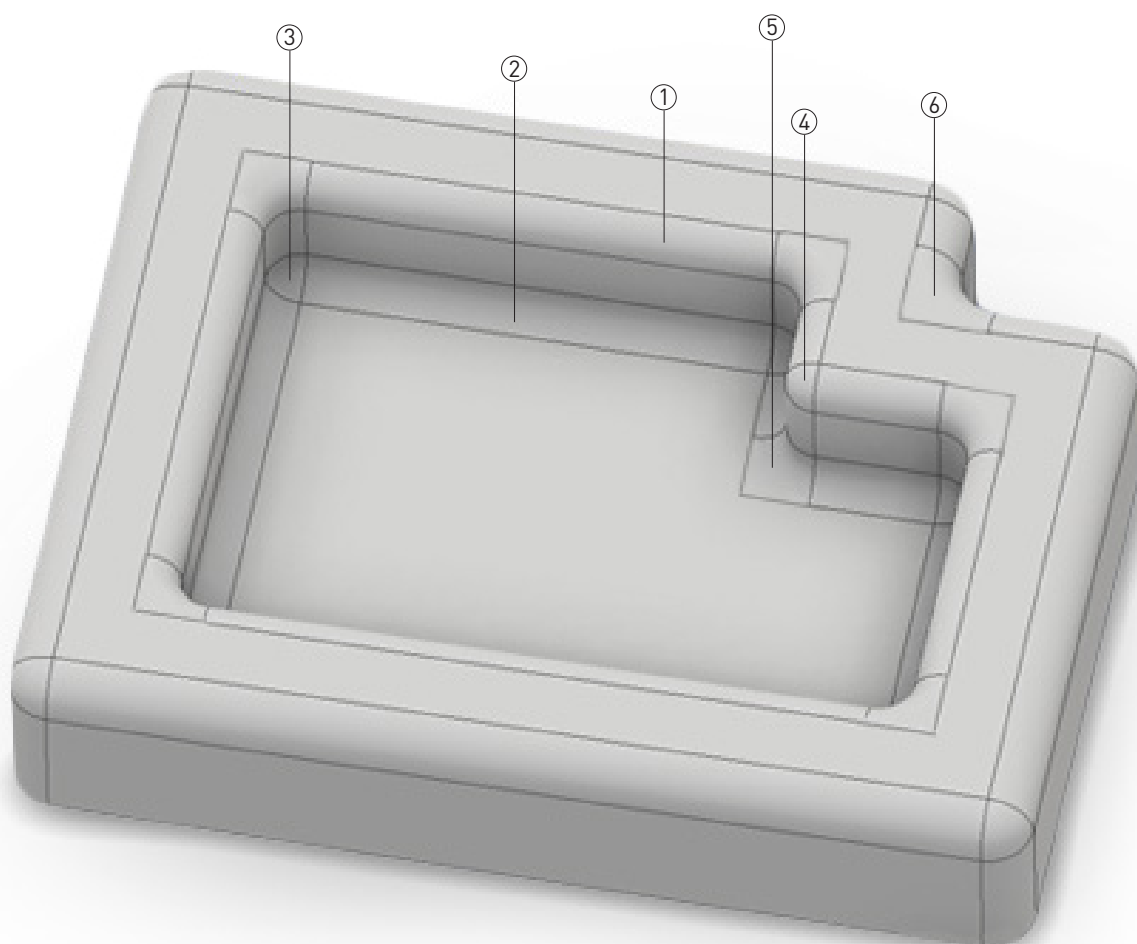

# SWIMMING POOL VESSEL CLADDING

## REVESTIMIENTO DEL VASO DE LA PISCINA

### FORMATS FORMATOS



31,6X31,6\* OUT  
**(M-494)** 



33X33\* OUT  
**(M-772)** 

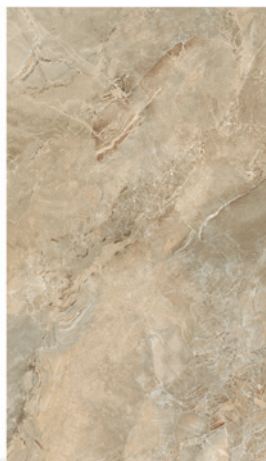

45X75<sup>R</sup> OUT  
**(M-711)** 



37,5X75<sup>R</sup> OUT  
**(M-770)** 



31X83\* OUT  
**(M-741)** 



20X83\* OUT  
**(M-740)** 



75X75<sup>R</sup> OUT  
**(M-769)** 



22,5X90\* OUT  
**(M-760)** 







## Porcelain tile Gres porcelánico



Resistencia a la abrasión  
Resistance to surface abrasion | **IV - V**



Resistencia a la helada  
Frost resistance | **✓**



Resistencia al choque térmico  
Thermal shock resistance | **✓**



Resistencia a la flexión  
Modulus of rupture | **>23N / mm<sup>2</sup>**



Antideslizante  
Antislip

UNE ENV 12633  
**Clase 3**



Antideslizante  
Antislip  
\*Hawaii & Mikonos Pool Systems

DIN 51130  
**R10 / R12\***



Antideslizante  
Antislip

DIN 51097  
**Clase C**



Resistencia a las manchas  
Stain resistance

**5**



Chemical resistance  
Resistencia química

**GA / GLA / GHA**



Resistencia al rayado  
Scratch resistance

**9**



Absorción de agua  
Water absorption  
IO 10545-3

**< 0,5 %**



Resistencia al fuego  
Fire resistance

**✓**



Resistencia al impacto  
Impact resistance

**✓**



Tolerancia dimensional  
Dimensional tolerance

**✓**